

**STARTING & CHARGING SYSTEM** ED486025

**STARTING & CHARGING SYSTEM (1)**

**SD360-1**

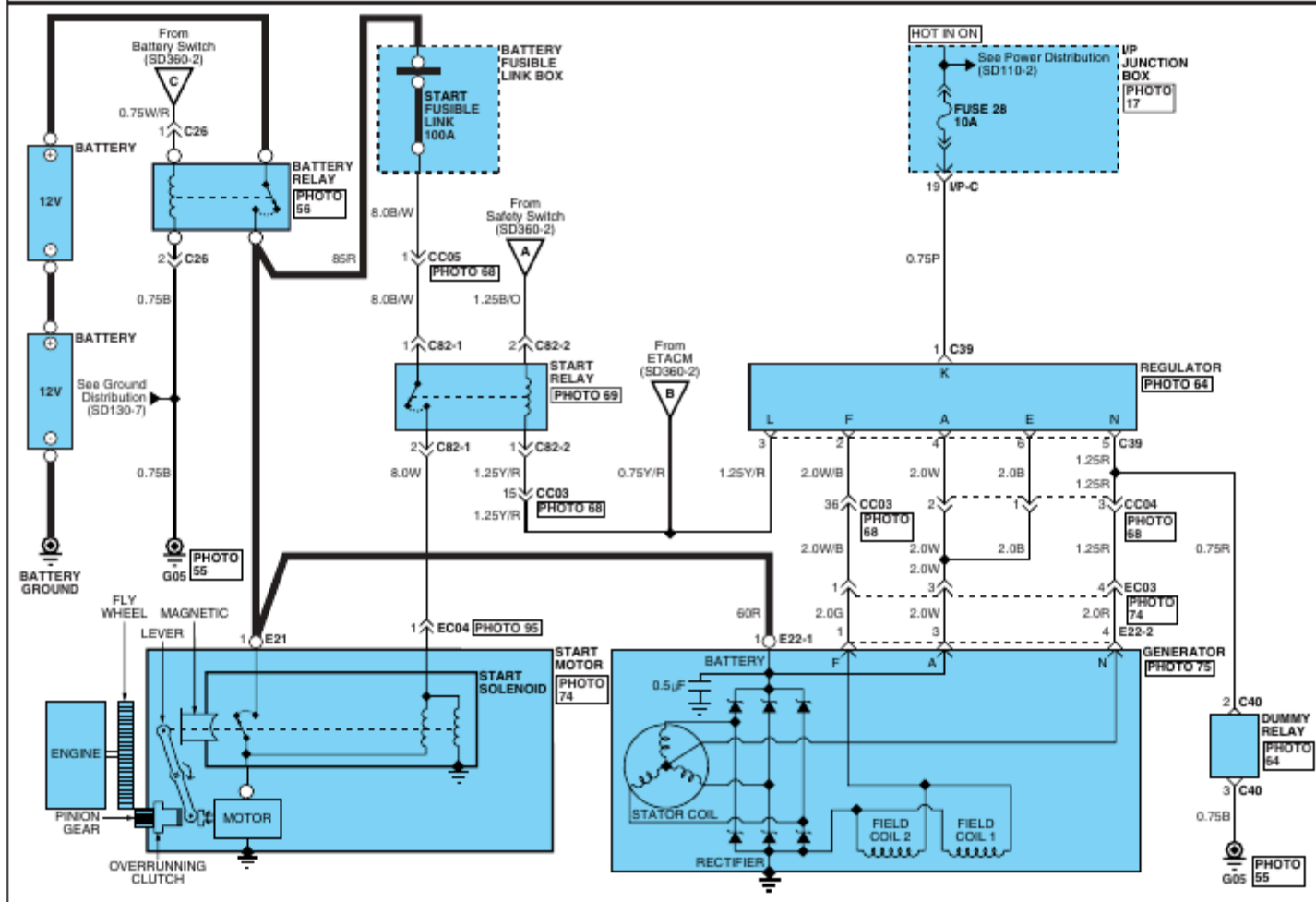







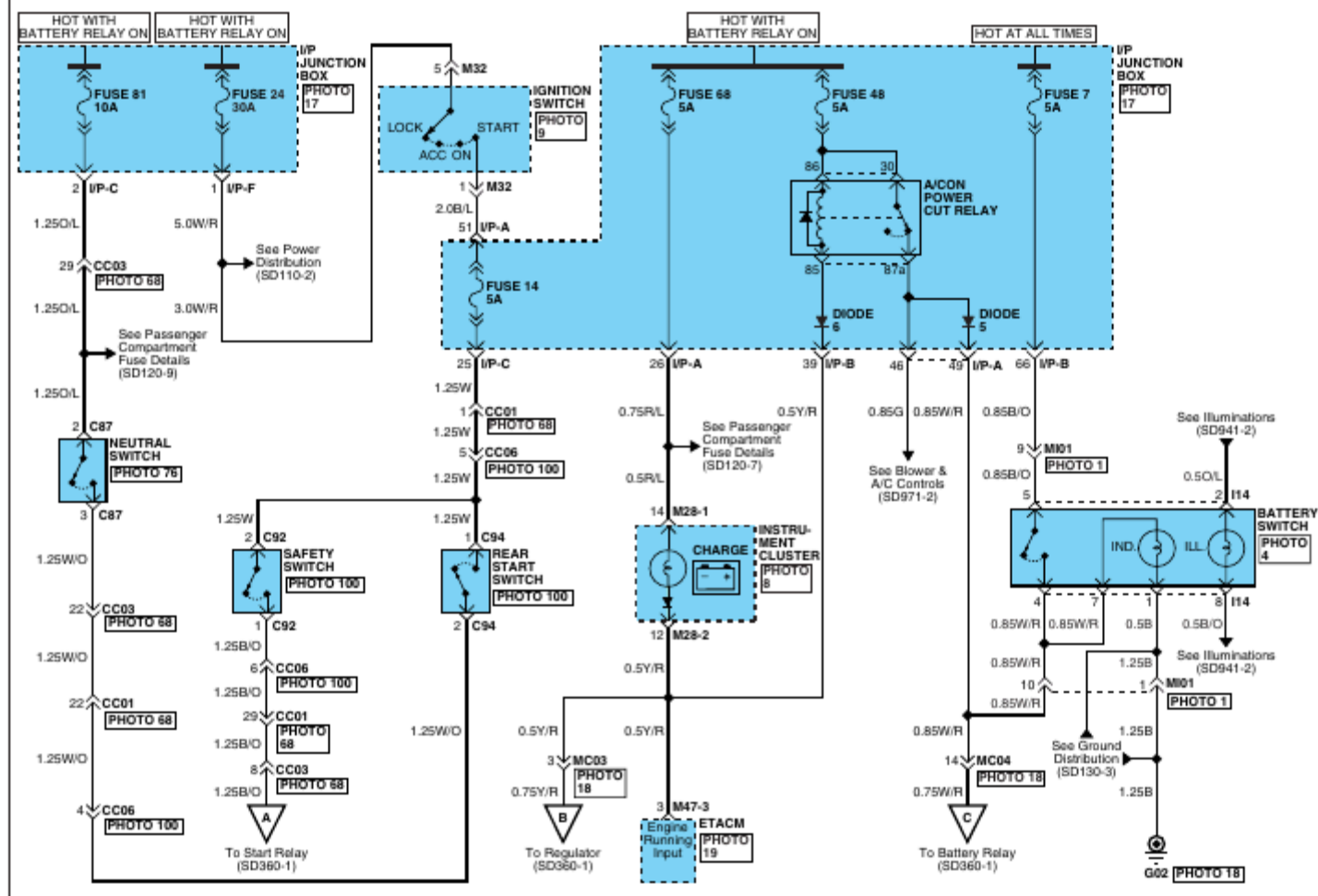

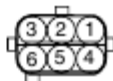

# STARTING & CHARGING SYSTEM

## STARTING & CHARGING SYSTEM (2)

SD360-2

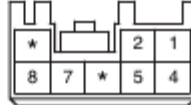
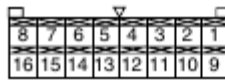
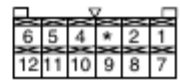
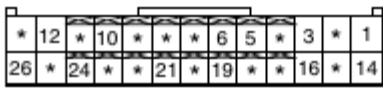

**STARTING & CHARGING SYSTEM**

STARTING & CHARGING SYSTEM (3)			SD360-3
<p><b>C26</b></p>  <p>CR02F040</p>	<p><b>C39</b></p>  <p>CR02F046</p>	<p><b>C40</b></p>  <p>CR03F020</p>	<p><b>C82-1</b></p>  <p>CR02F186</p>
<p><b>C82-2</b></p>  <p>CR02F040</p>	<p><b>C87</b></p>  <p>CR04F067</p>	<p><b>C92</b></p>  <p>CR02F050</p>	<p><b>C94</b></p>  <p>CR02F040</p>
<p><b>E21</b></p>  <p>CR01F034</p>	<p><b>E22-1</b></p>  <p>CR01F034</p>	<p><b>E22-2</b></p>  <p>CR04F102</p>	<p><b>I14</b></p>  <p>CR06F070</p>
<p><b>M28-1</b></p>  <p>CR16F019</p>	<p><b>M28-2</b></p>  <p>CR12F031</p>	<p><b>M47-3</b></p>  <p>CR26F019</p>	